

This installation guide is valid for the following models:

- Wyplash – WPUS
– WPUT



PRIOR TO INSTALLATION



- Read all instructions to prevent injury, electric shock or damage due to fire or mechanical hazards
- See product label for supply specifications
- Suitable for recessed or suspension mounting

Inspect the luminaire and associated parts for any signs of defect, in particular fasteners, cables and the diffuser or glass lens

DO NOT INSTALL THE LUMINAIRE IF IT APPEARS IN ANY WAY FAULTY

Consult with the supplier / sales office for details regarding replacement



CAUTION



- Installation is to be completed by a competent licensed electrician, in accordance with these instructions and relevant local regulations.
- Electronic control equipment must not be subjected to high voltages, DO NOT MEGGER between Live and Neutral.
- All cable/conduit terminations must be installed in accordance with the designated IP rating of this product.
- Suitable installation fastening methods should be employed to ensure the mounting points are not damaged when subjected to vibration and or movement.
- The light source contained in this luminaire shall only be replaced by the manufacturer or his service agent or similar qualified person.
- When using glands provided as cord anchorage for flexible cable the cable diameter shall not be less than 8.4 mm and not larger than 12 mm.

DIMENSIONS

WPUS

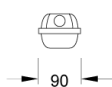

WPUT

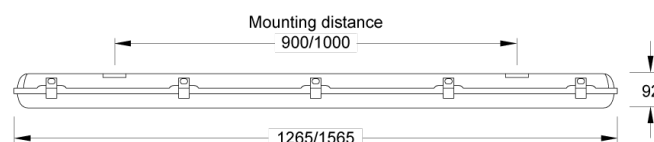
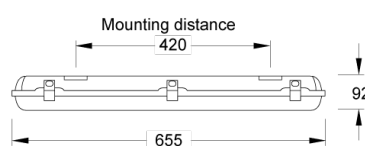
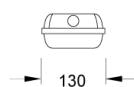

INSTALLATION

1. Install cover clamps to the body.

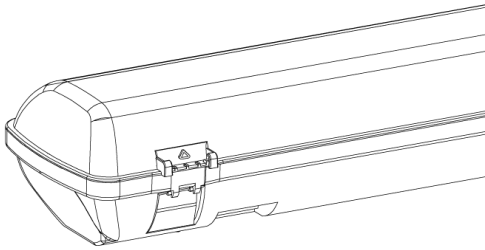

2. Secure brackets to mounting surface as per measurements provided opposite.

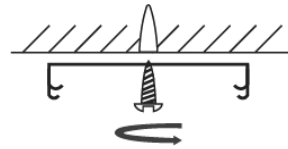

3. Hook the body into the mounting brackets.

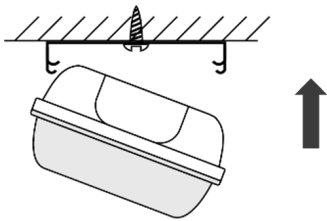

4. Open diffuser by unlocking all clamps. If clamps are secured with screws, undo screws first.

Note: The diffuser will be retained by rear clamps

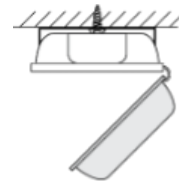

5. Release gear tray by pressing the steel clip as shown. Ensure lanyards are hooked into gear tray for safety.

LED

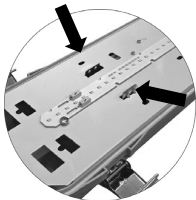

T8/T5

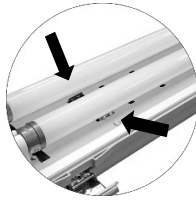

6. Cut-out cable entry hole either from back or end. Bring the mains supply cables. Use compression gland for round cable. If supply cables are from the back or through conduit, ensure all holes are sealed to prevent water ingress.

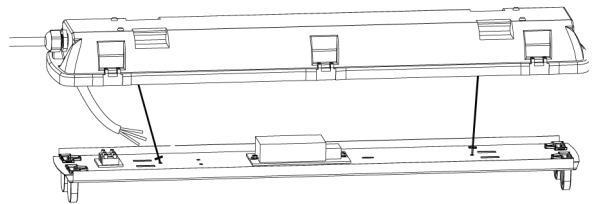

7. Connect supply cables to terminal block. To maintain EMC compliance, supply cables must be kept away from any lamp wires.

 L = Live/Active (BROWN)

 = Earth (YELLOW-GREEN)

 N = Neutral (BLUE)

8. Replace and secure gear tray.

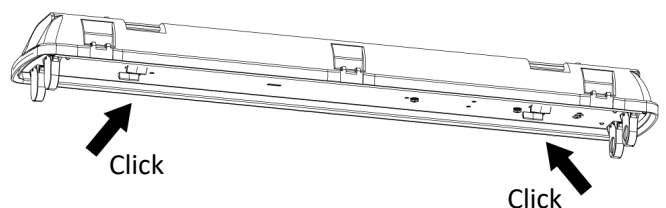

9. Replace cover and latch the clamps. Tighten it with screw.

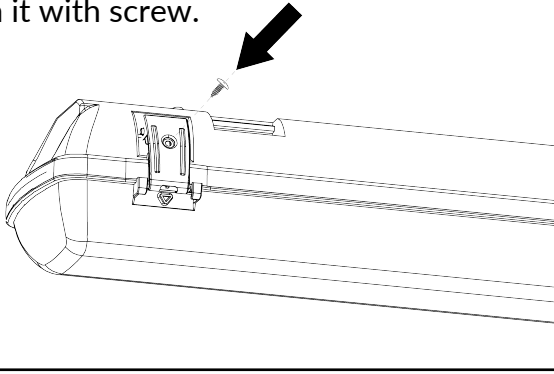

Recommended mounting position. For other mounting position please check with sales office

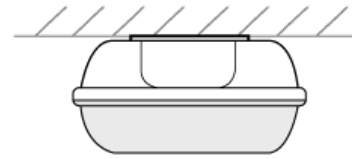

Unauthorized modification & improper installation void product warranty

EMERGENCY POWER PACK

GENERAL INSTALLATION

**If the product comes with an EMERGENCY POWER PACK, please continue from here.*

TECHNICAL SPECIFICATION FOR EMERGENCY KIT

Consumption:	3W Max and 1W standby
Emergency Output:	2W (constant power output)
Duration Time:	3Hr (minimum)
Recharge Period:	> = 16 hours



CAUTION



- Installation, maintenance or replacement of battery must be carried out by qualified electrician according with these instructions, local rules and codes.
- Installer must plug in the battery connector during installation of the emergency fitting.
- Ensure unswitched active (UA) is connected same phase with the Active (A or L).

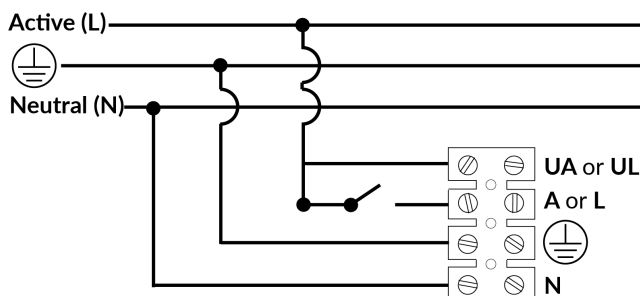

Wiring Diagram

FUNCTIONAL TEST

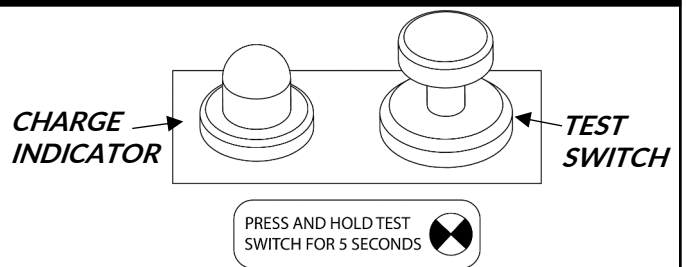

In **NORMAL** mode, the charge indicator LED will be lit to indicate battery charging.

When the *Test Switch* is pressed, the charge indicator LED will turn off and the Emergency lamp will switch over to **EMERGENCY** lighting mode. It is recommended to press and hold the *Test Switch* for at least 5 seconds for this test.

When the *Test Switch* is released, the fitting will return to **NORMAL** mode.

MAINTENANCE

The supply must be isolated before opening or accessing the luminaire. Product maintenance is critical to the products designed performance. Davis Lighting is not responsible for any product not maintained in accordance with the recommended procedure or intervals. It is recommended that a bi-annual cleaning cycle is implemented. Inspect optical surfaces for damage or crack. Products supplied with visors or covers must not be operate with a damaged visor or cover; it is recommended damaged visors or covers be replaced by a competent person immediately. Seals and electrical components such as wirings to be checked for deterioration.



All photometric and electrical data published are of $\pm 10\%$ tolerance. Characteristics and specifications may change without notice. All electrical installations / connections should be carried out by a suitably qualified person. Application images are indicative only and may not contain actual Davis product. The information contained in this publication is typical and must not be interpreted as a guarantee of individual product performance.

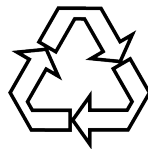

This product may contain substances that can be hazardous to the environment if not disposed of correctly. Electrical and electronic equipment should never be discarded along with general waste but should be separated for correct treatment and recovery. Packaging and waste materials should be recycled wherever possible.

CONTACT

Australia Head Office & Sales

Davex Australia Pty Ltd
Head Office: +61 (7) 3712 8988
Sales Offices: 1300 851 001
Fax: +61 (7) 3272 8988
Email: australia@davislighting.com

Malaysia Head Office & Sales

Davex Malaysia Sdn Bhd (114942-X)
Phone: +60 (3) 5636 4348
Fax: +60 (3) 5636 4352
Email: malaysia@davislighting.com

Singapore Head Office & Sales

Davex Singapore Pte Ltd
Phone: +65 6745 2511
Fax: +65 6745 5828
Email: singapore@davislighting.com