

*Please read the 11th instruction carefully before using this product, since the performance of DC-powered microwave products is closely related to the stability and characteristics of the auxiliary power supply of the LED driver.

1. Features

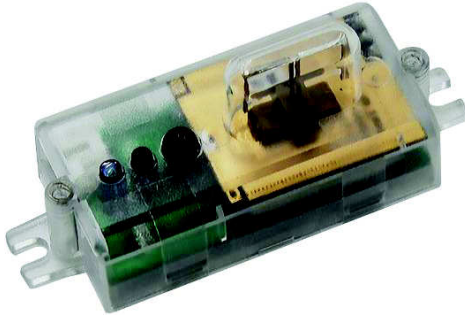

- Patent Bipolar antenna, no blind detection area when compared with traditional needle antenna
- Stable performance when mount in metal roof environment
- Slim cut hole size
- Parameters can be set by remote control MH10
- 5 years warranty

2. Parameter

Input	DC Input Voltage	12±1V DC
	Rated Voltage	12V DC
	Voltage Ripple	<300mVp-p
	Stand-by Power	<0.5W
Output	Working Mode	5V high and low voltage signal, 0-10v signal
Sensor Parameters	Operating Frequency	5.8 GHz ±75 MHz, ISM Band.
	Transmitting power	0.5mW Max.
	Hold time	5S/30S/1min/3min/5min/10min/20min/30min
	Stand-by DIM Level	10%(1.4-1.6V), 20%(1.9-2.1V), 30%(2.9-3.1V), 50% (4.9-5.1V)
	Twilight Time	0s/10S/1min/3min/5min/10min/30min/+∞
	Detection Area	25%/50%/75%/100%
	Daylight Sensor	5lux/15Lux/30Lux/50Lux/100lux/150lux/Disable Daylight priority: ON / OFF value (5lux/15Lux/30Lux/50Lux)/150Lux 100Lux/200Lux 150Lux/300Lux
	Detecting Radius	≥4m (mounting height 3m, moving speed 0.3m/s)
	Mounting Height	6m Max
	Detecting Angle	150°
Operating Environment	Operating Temperature	-25°C...+60°C
	Storage Temperature	Temperature: -40°C...+80°C; Humidity: 10%-95% (non-condensing)
	EMC standards	EN55015, EN61000-3-2, EN61000-3-3, EN61547
	Environmental Requirement	Compliant to RoHS

Others	Wiring	3 pin 2.0mm fast connector
	IP Rating	IP20
	Protection Class	Class II
	Installation	Base installation
	Dimension	See dimension
	Package	cartons
	Net Weight	18g
	Lifetime	5 years warranty@Ta 230V full load

Note

1. "N/A" means not available.
2. The detection range of the sensor is related to the moving speed and size of moving object, mounting height, installation height and angle, installation site, reflectors around the sensor etc. The data in the document is typical value and tested by a 165cm person in an open indoor area.
The detection range at wall mounting will be longer at ceiling mounting. Please reduce detection sensitivity at wall mounting or contact us to confirm the sensor data settings.

3. Function

1) On/OFF Function (stand-by period be set to "0s")

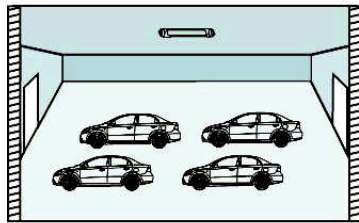

1 With sufficient ambient light, the light will not be switched on even if with motion signal.

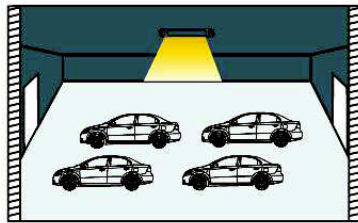

2 With insufficient ambient light, the sensor switches on the light when motion is detected.

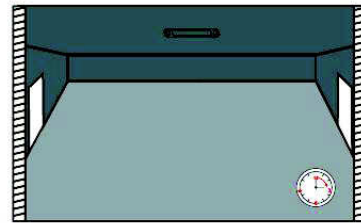

3 After elapse of hold time, the sensor switches off the light when no motion is detected.

2) 2-step dimming function (stand-by period be set to "+∞")

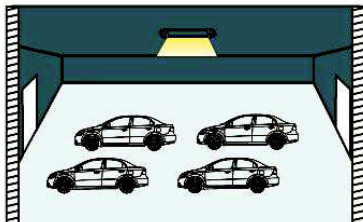

1 If there is no motion detected, the light will be remained at a low light level all the time.

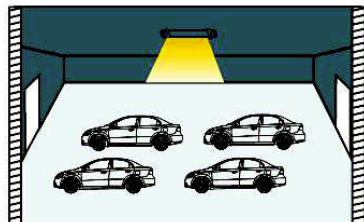

2 When motion is detected, the sensor will switch on the light to 100% brightness

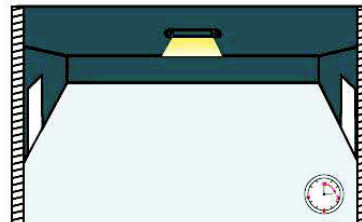

3 After elapse of hold time, the sensor dims the light at the present low light level if no motion is detected.

3) 3-step dimming function (stand-by period be set to “10s/30s/1min/3min/5min/10min/30min”)

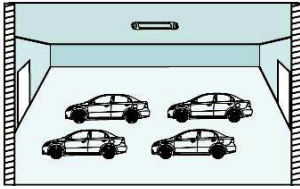

1 With sufficient ambient light, the light will not be switched on even if with motion signal.

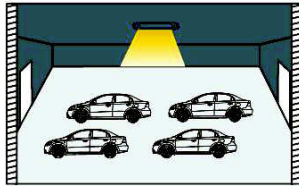

2 With insufficient ambient light, the sensor switches on the light when motion is detected.

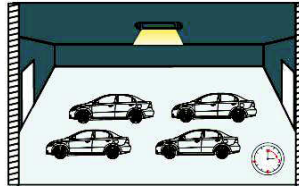

3 After elapse of hold time, the sensor dims the light at a low light level if no new motion is detected.



4 After elapse of standby period, the sensor switches off the light if no motion is detected in the detection zone.

4. Dimension (mm)

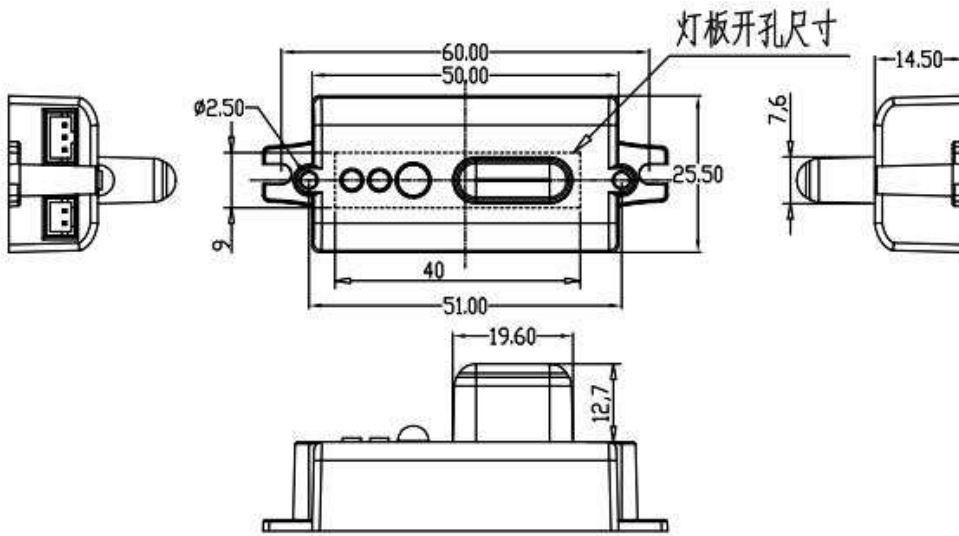

5. Wiring

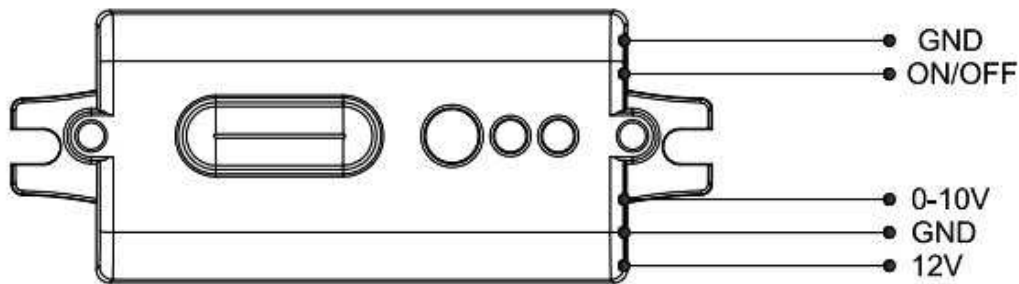

*The sensor is designed for connect one load only. Connect more than one loads may damage the sensor.

*Without auxiliary 12Vdc interface driver, MC103S can be an option of power supply for sensor

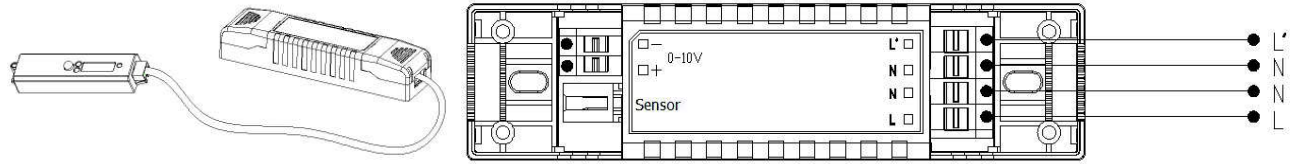

6. Structure and installation

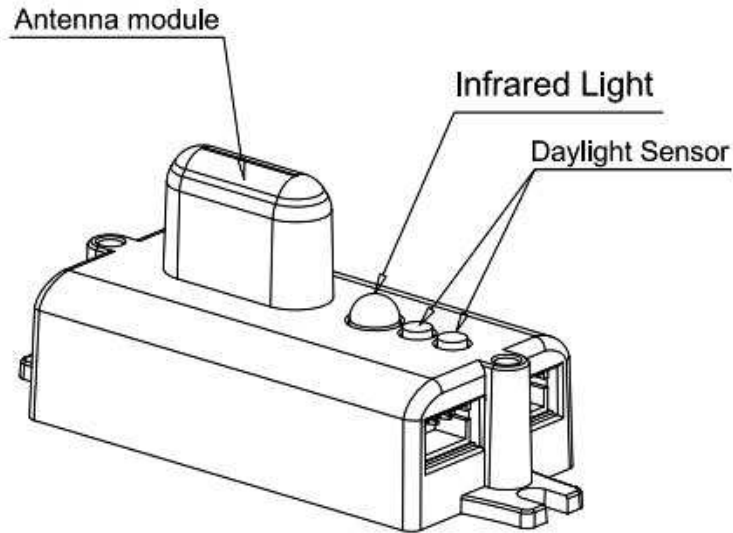

7. Installation directive



1. Cut a suitable opening size.



2. Put the product into the opening, and fasten it with screws.

8. Radiation Pattern (Ceiling mounting)

Ceiling mounted height: 3m
Sensitivity: 100%/75%/50%/25%

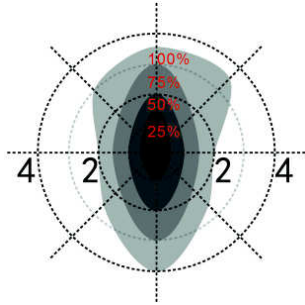

Normal moving (Speed: 1m/s)

Ceiling mounted height: 3m
Sensitivity: 100%/75%/50%/25%

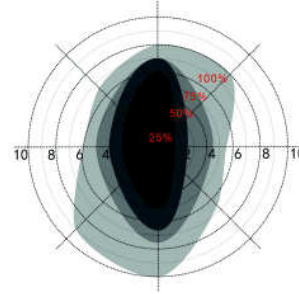

Slow moving (Speed: 0.3m/s)

9. Remote control

Remote Control Setting	Button	Remarks																												
	ON/OFF	Press the "ON/OFF" button, the light goes to constant on/off mode, sensor is disabled. Press "Reset" "Auto mode" button to quit from this mode and the sensor starts to work. No memory for ON-OFF setting after power off. Sensor mode will auto recover after restart power supply.																												
	Reset	Press "Reset" button, all parameters are same as setting of DIP switch or factory settings.																												
	Sensor motion	Press "Sensor motion" button, the light quits from the constant on/ off mode, and the sensor starts to work (The latest setting stays in validity)																												
	DIM Test	Press "DIM Test" button, the 1-10 V dimming works to test whether the 1-10Vdc dimming ports are connected properly. After 2s, it returns to the latest setting automatically.																												
	Override DH	Long press 3s, Daylight priority mode will be switched to daylight threshold mode, lux value will go back to previous one.																												
	DIM+ DIM-	Short press "Dim+/Dim-" button to Set the output lumen level, each press will $\pm 2\%$ light level.																												
	DH Mode	Long press >3s, sensor will be switched to daylight priority mode, if preset daylight value is Disable, press DH Mode can not start daylight priority mode.																												
	Q1 Q2 Q3	<table border="1"> <thead> <tr> <th>Scene Options</th> <th>Detection Area</th> <th>Hold Time</th> <th>Stand-by period</th> <th>Stand-by dim level</th> <th>Daylight Sensor</th> <th>Induction model</th> </tr> </thead> <tbody> <tr> <td>QS1</td> <td>100%</td> <td>5min</td> <td>10min</td> <td>10%</td> <td>30Lux</td> <td>HS</td> </tr> <tr> <td>QS2</td> <td>100%</td> <td>10min</td> <td>30min</td> <td>10%</td> <td>Disable</td> <td>HS</td> </tr> <tr> <td>QS3</td> <td>100%</td> <td>20min</td> <td>30min</td> <td>10%</td> <td>Disable</td> <td>HS</td> </tr> </tbody> </table> <p>Note: Detection area / Hold time / Stand-by period / Stand-by dim level / Daylight sensor can be adjusted by pressing the corresponding button. The latest setting will stay valid.</p>	Scene Options	Detection Area	Hold Time	Stand-by period	Stand-by dim level	Daylight Sensor	Induction model	QS1	100%	5min	10min	10%	30Lux	HS	QS2	100%	10min	30min	10%	Disable	HS	QS3	100%	20min	30min	10%	Disable	HS
Scene Options	Detection Area	Hold Time	Stand-by period	Stand-by dim level	Daylight Sensor	Induction model																								
QS1	100%	5min	10min	10%	30Lux	HS																								
QS2	100%	10min	30min	10%	Disable	HS																								
QS3	100%	20min	30min	10%	Disable	HS																								
	TEST 2S	Press the "TEST 2S" button can enter the test mode any time. At the mode, the sensor parameters as below: Detection Area is 100%, Hold Time is 5s, Stand-by Dim Level is 10%, Stand-by Period is 0s, daylight sensor disable. This function only for testing. Quit the mode by pressing "RESET" or any other function buttons.																												
	HS LS	N/A																												
	Daylight Sensor	Set up daylight threshold: 5Lux/15Lux/30Lux/50Lux/100Lux/150Lux/ Disable																												
	Stand-by period	Set up stand-by time: 0S/10S/1min/3min/5min/10min/30min/+∞																												
	Hold time	Set up hold time: 5S/30S/1min/3min/5min/10min/20min/30min																												
	Stand-by dim level	Set up stand-by dim level: 10%/20%/30%/50%																												
	Detection Area	Set up detection area: 25%/50%/75%/100%																												
	N/A	N/A																												

Shenzhen Merrytek Technology Co.,Ltd

Add: No.17th Building, Dianda Guyuan Industrial Park, Mashantou, Matian, Guangming District, Shenzhen, China, 518106
Tel: +86 (0)755-2305 7253 Fax: +86 (0)755-2786 3012 Website: www.merrytek.com

10. Factory Setting

Detection area: 100%, Hold Time: 5S, Stand-by Period: 0s, Stand-by dim level: 10%, Daylight Sensor: Disable

11. Application Notice

- 1) The sensor should be installed by a professional electrician. Please turn off the power before installing, wiring, changing the setting of the DIP switch.
- 2) The sensor which installed in the plastic and glass lampshade will reduce the sensitivity. For every 3mm increase in thickness, the sensitivity will be reduced by 20%.
- 3) The dimming performance could be different from different 0/1-10v drivers.
- 4) The light sensitivity threshold is in a sunny environment, no shadow and ambient light diffuse reflection. Ambient lux level could be different in different environment, weather, climate, time-of-day and season.
- 5) The parameters of the sensor may need to be reconfigured in different installation environments. Please refer to the following instructions or contact the manufacturer.
- 6) Sensor could be triggered by wind and rain, as well as the moving objects nearby, if apply outdoor.
- 7) The mounting height is no more than 4m, proper mounting height is 3m; the distance between any inductive sensors should be greater than 3m.
- 8) Do not place the sensor close to high-density objects such as metal, glass, concrete walls, etc, false triggering could happen. When the sensor is installed in a metal lamp, metal reflective surface, or a narrow enclosed environment, the microwave will be reflected repeatedly and cause false triggering. Please reduce the sensitivity or contact the manufacturer for technical support.
- 9) Please ensure that there are no moving signals around the sensor, such as fan, DC motor, sewer pipe, air outlet, etc., the sensor may generate false trigger.
- 10) You are advised to test 5 samples before mass application of sensor in a new lighting project.
- 11) Due to continuous improvement, the contents of this instruction could be changed without prior notice
- 12) A stabilized DC power supply with stable output voltage and low ripple must be used, the power supply ripple should be less than 300mV, and the load current should be greater than 25mA.