

# Nussa - NUL

Commercial Lighting / Low Glare Technology Troffer



A premium recessed louvre luminaire with custom designed high grade aluminium (Miro Silver) louvre to deliver optimal lighting outcome for a wide range of commercial applications.

## Features

- Excellent optics control with use of anti-glare high grade aluminium silver (Miro Silver) louvre
- Flicker free and uniform illumination to ensure maximum level of lighting comfort
- Highly customisable lumen output and system power
- Smart system ready - DALI DT6 and DT8 Tunable White options available
- Complies with J6 and UGR19\*
- CRI >90 as standard
- COI compliant

## Applications

- Office
- Boardroom
- Education
- Healthcare

## Options

- Air Handling
- DALI DT6 and DT8
- Tunable White
- Customizable size
- Motion sensor & daylight harvesting

## Standards

- Manufactured under ISO 9001:2015 to standards
- IEC/AS/NZS 60598.1
- IEC/AS/NZS 60598.2.1
- IEC/AS/NZS 60598.2.2
- IEC/AS/NZS CISPR 15

## Mounting Methods

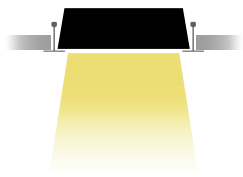

T-Bar Lay-in

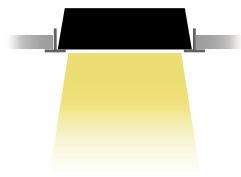

Plaster Recessed  
*-with plaster frame*



**SELV**

OPTIONAL

\* Based on typical office simulation

# Nussa - NUL

Commercial Lighting / Low Glare Technology Troffer



## Product Code Key

Model	Nominal Size	Power	-	Air Handling	CRI & Colour Temp.	Dimming
NUL	2 = 600x300mm	10 = 10W		A10 = Side Air	R83 = CRI>80, 3000K	D10 = DALI
	M2 = 600x400mm	15 = 15W		A21 = Concealed Air	R84 = CRI>80, 4000K	
	4 = 1200x300mm	20 = 20W			R93 = CRI>90, 3000K	
	M4 = 1200x400mm	25 = 25W			R94 = CRI>90, 4000K	
		30 = 30W				
		35 = 35W				
		40 = 40W				
	W2 = 600x600mm	20 = 20W				
		25 = 25W				
		30 = 30W				
		35 = 35W				
		40 = 40W				
W4 = 1200x600mm	20 = 20W			Side air handling available only for NULW2, NULW4, NULM2, NULM4		
	25 = 25W					
	30 = 30W					
	35 = 35W			Omit for standard non air handling		Omit for standard non dimmable
	40 = 40W					

e.g. NUL420-R84D10 = NUL 1200x300mm, 20W, CRI>80, 4000K, DALI

## Model Number Example

Model code: NUL420-R94D10

Model Number	NUL	4	20	-	R94	D10
Description	Nussa	1200x300mm	20W	-	CRI>90, 4000K	DALI

Model code: NULW230-A10R94

Model Number	NUL	W2	30	-	A10	R94
Description	Nussa	600x600mm	30W	-	Side Air Handling	CRI>90, 4000K



### Specifications

Base Model	NUL / NULM420	NUL / NULM425	NUL / NULM430	NUL / NULM435	NUL / NULM440
Nominal Power (W)	20	25	30	35	40
Input Voltage	220 - 240 VAC 50 / 60 Hz				
Luminaire Flux (lm)*	2776	2938	3513	3825	4452
Luminaire Efficacy (lm/W)*	115	115	113	113	111
CRI	>90 (>80 optional)				
Power Factor	> 0.90				
Colour Temp. (K)	3000 / 4000				
Luminaire Rated Life (hrs)	> 50,000				
UGR	< 19 **				
SDCM	< 3				
Operating Temp. (°C)	-20 to +35				
Weight (kg)	4.0				

Base Model	NUL / NULM210	NUL / NULM215
Nominal Power (W)	10	15
Input Voltage	220 - 240 VAC 50 / 60 Hz	
Luminaire Flux (lm)*	1322	1758
Luminaire Efficacy (lm/W)*	107	108
CRI	>90 (>80 optional)	
Power Factor	> 0.90	
Colour Temp. (K)	3000 / 4000	
Luminaire Rated Life (hrs)	> 50,000	
UGR	< 19 **	
SDCM	< 3	
Operating Temp. (°C)	-20 to +35	
Weight (kg)	2.0	

Base Model	NULW220	NULW225	NULW230	NULW235
Nominal Power (W)	20	25	30	35
Input Voltage	220 - 240 VAC 50 / 60 Hz			
Luminaire Flux (lm)*	2768	2959	3556	3882
Luminaire Efficacy (lm/W)*	116	116	115	114
CRI	>90 (>80 optional)			
Power Factor	> 0.90			
Colour Temp. (K)	3000 / 4000			
Luminaire Rated Life (hrs)	> 50,000			
UGR	< 19 **			
SDCM	< 3			
Operating Temp. (°C)	-20 to +35			
Weight (kg)	3.0			

\*Specifications shown for 4000K

\*\* Subject to design & room parameters

More output option available, please contact nearest sales office for more information



## Lighting Data

NUL215

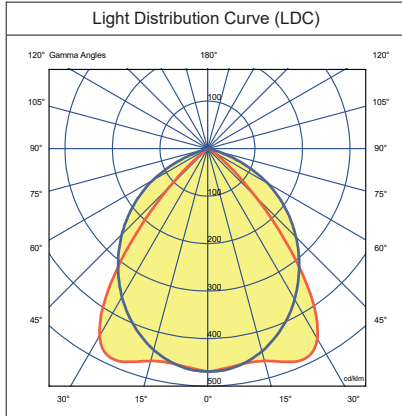

NUL430

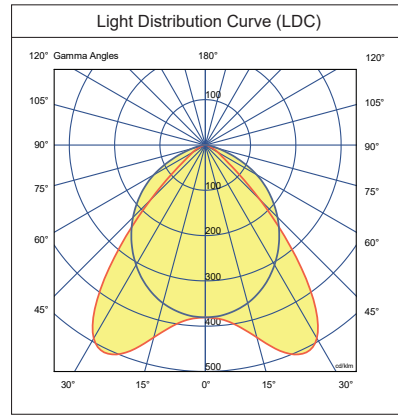

NULM215

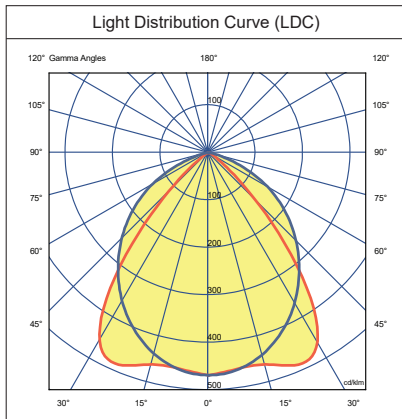

NULM430

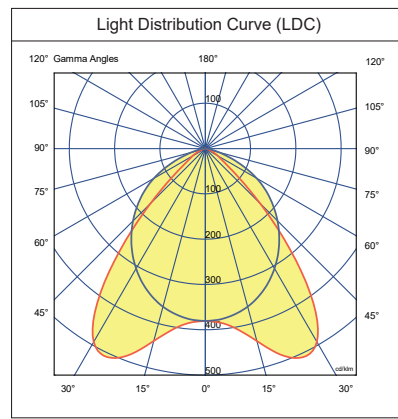

NULW230

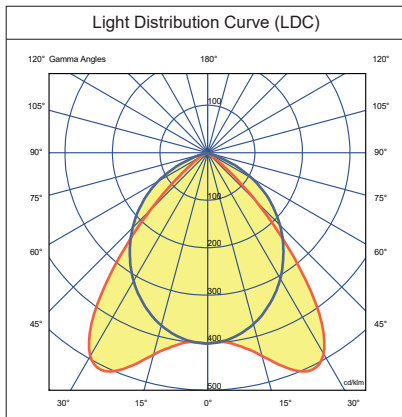

NULW430

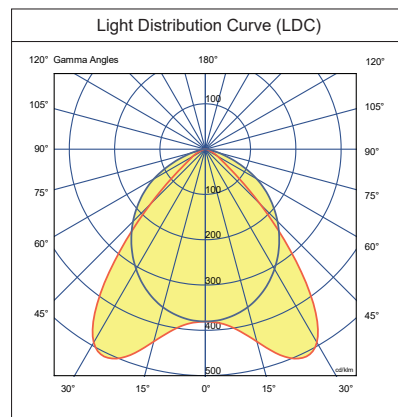

IES files available

# Nussa - NUL

Commercial Lighting / Low Glare Technology Troffer



DAVISLIGHTING

## Dimensions

NUL4 - 1200x300 mm

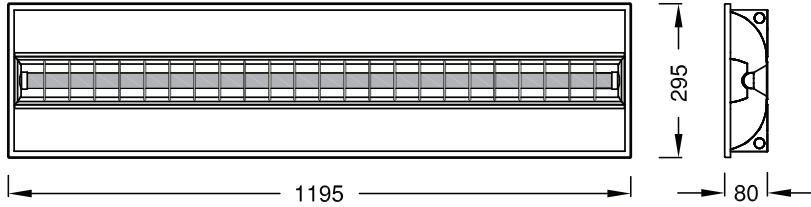

NUL2 - 600x300 mm

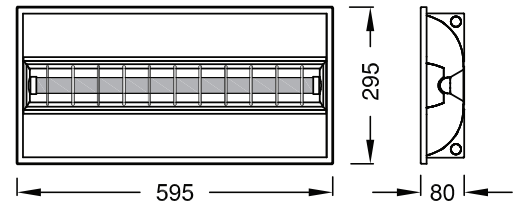

NULW4 - 1200x600 mm

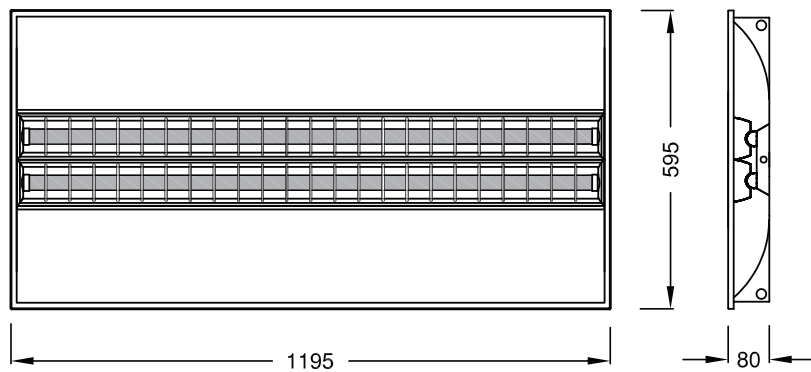

NULW2 - 600x600 mm

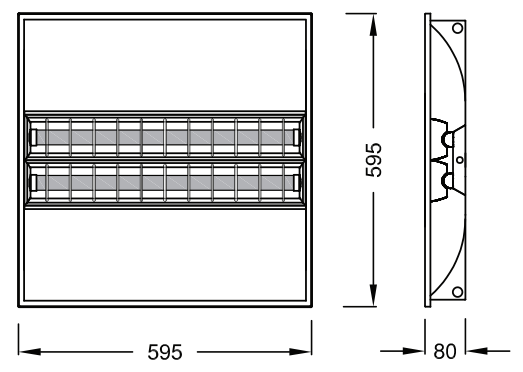

NULM4 (Air Handling) - 1200x400 mm

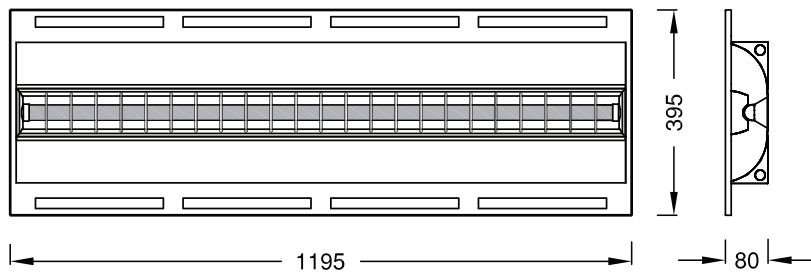

NULM2 (Air Handling) - 600x400 mm

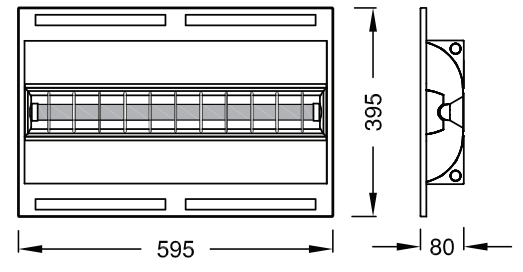

NULW4 (Air Handling) - 1200x600 mm

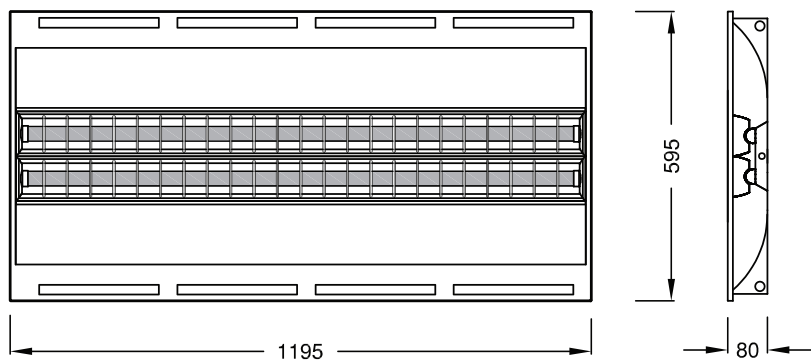

NULW2 (Air Handling) - 600x600 mm

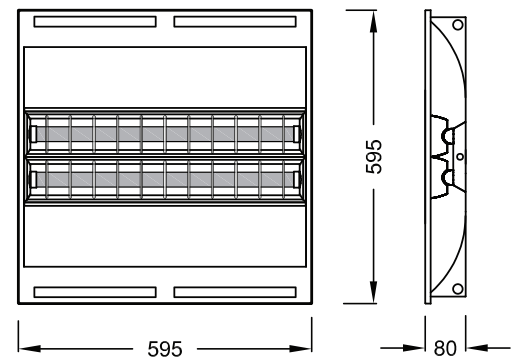

davislighting.com



davislighting.com.au

All photometric and electrical data published are of  $\pm 10\%$  tolerance. Characteristics and specifications may change without notice. All electrical installations / connections should be carried out by a suitably qualified person. Application images are indicative only and may not contain actual Davis product. The information contained in this publication is typical and must not be interpreted as a guarantee of individual product performance.

NUL 220518