

## Installation Instruction



### BT – T5 LED Batten

**WARNING: UNLESS OTHERWISE SPECIFIED, BY DEFAULT THIS BATTEN IS WIRED FOR TYPE B LED LAMP ONLY.**



- Read all instructions to prevent injury, electric shock or damage due to fire or mechanical hazards.
- See product label for supply specifications.
- Suitable for direct mounting on flammable surfaces
- Ta: 35°C

#### Storage:

Prior to installation products are to be stored in cool and dry conditions.

#### Dimensions:

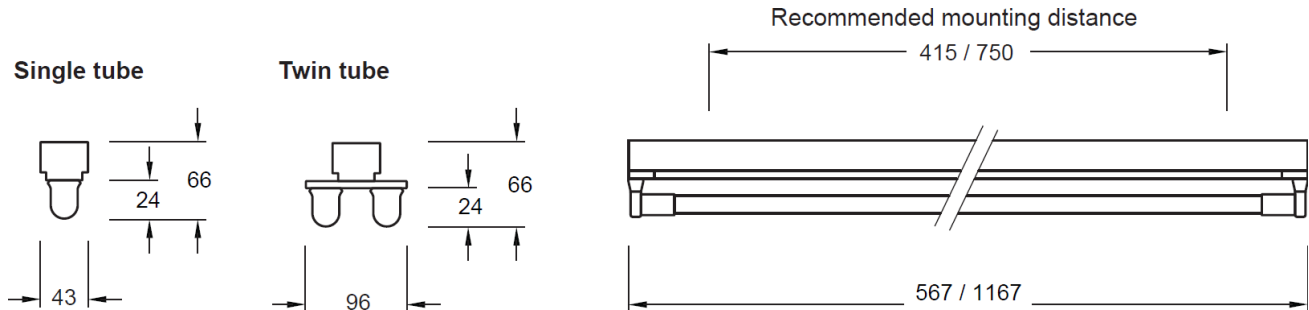

#### Cautions:

- Installation is to be completed by a competent licensed electrician, in accordance with these instructions and relevant local regulations.
- Electronic control equipment must not be subjected to high voltages, DO NOT MEGGER between Live and Neutral.
- All cable/conduit terminations must be installed in accordance with the designated IP rating of this product.
- Suitable installation fastening methods should be employed to ensure the mounting points are not damaged when subjected to vibration and or movement.

#### Installation:

1. Loosen screws at both end of the fitting to remove cover plate.

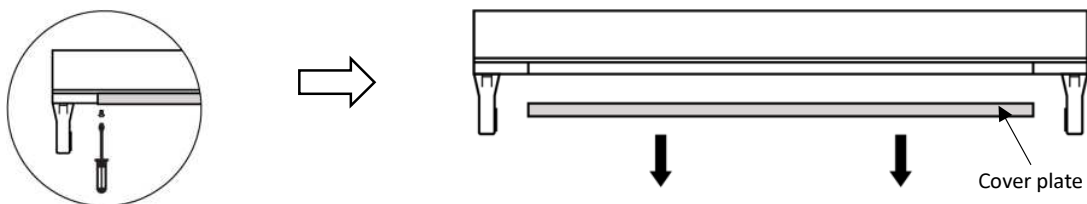

2. Mount the fitting to ceiling with screws.

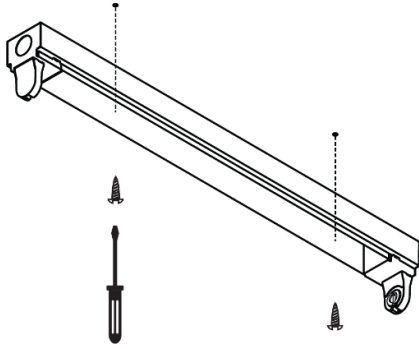

3. Connect incoming supply cables to the terminal block.

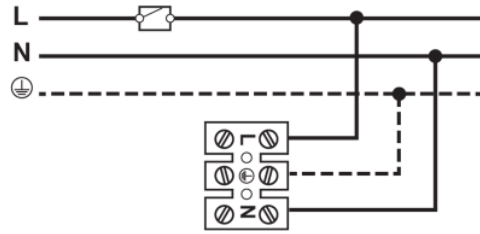

4. Install cover plate to the fitting and tighten with screws properly.

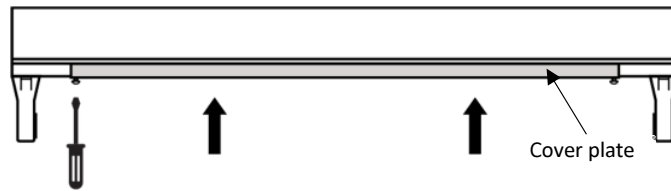

5. Install LED tube to lamp holders and secure by turning it 90°.

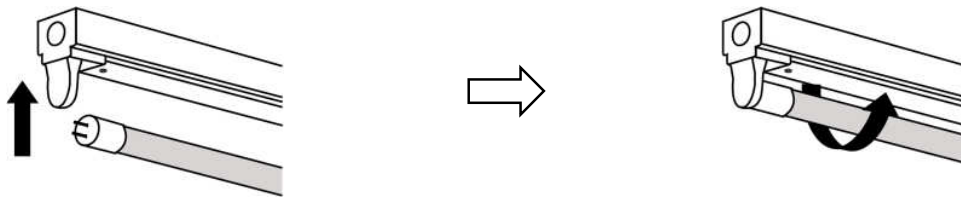

**Wiring Installation for Type B LED Lamp**

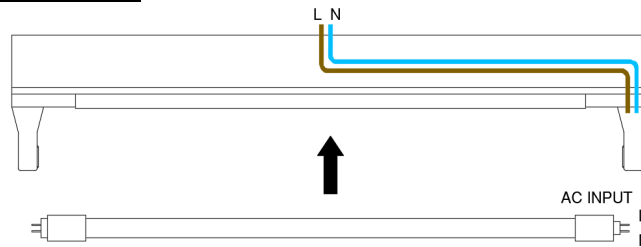

**Type B LED Lamp**

**Maintenance:** The supply must be isolated before opening or accessing the luminaire. Product maintenance is critical to the products designed performance. The product is to be maintained in accordance with the manufacturer’s instructions. For the latest product maintenance guides please go to [www.davislighting.com](http://www.davislighting.com). Davis Lighting is not responsible for any product not maintained in accordance with the recommended procedure or intervals. For recommended LAMP / LED maintenance guides, please refer to the lamp installation guidelines supplied with the lamp product or the nominated lamp manufacturer’s website. Products supplied with visors or covers must not be operate with a damaged visor or cover; it is recommended damaged visors or covers be replaced by a competent person immediately.



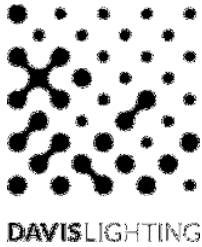

## Installation Instruction



### BT – T5 LED Batten

**WARNING: UNLESS OTHERWISE SPECIFIED, BY DEFAULT THIS BATTEN IS WIRED FOR TYPE B LED LAMP ONLY.**



- Read all instructions to prevent injury, electric shock or damage due to fire or mechanical hazards.
- See product label for supply specifications.
- Suitable for direct mounting on flammable surfaces
- Ta: 35°C

#### Storage:

Prior to installation products are to be stored in cool and dry conditions.

#### Dimensions:

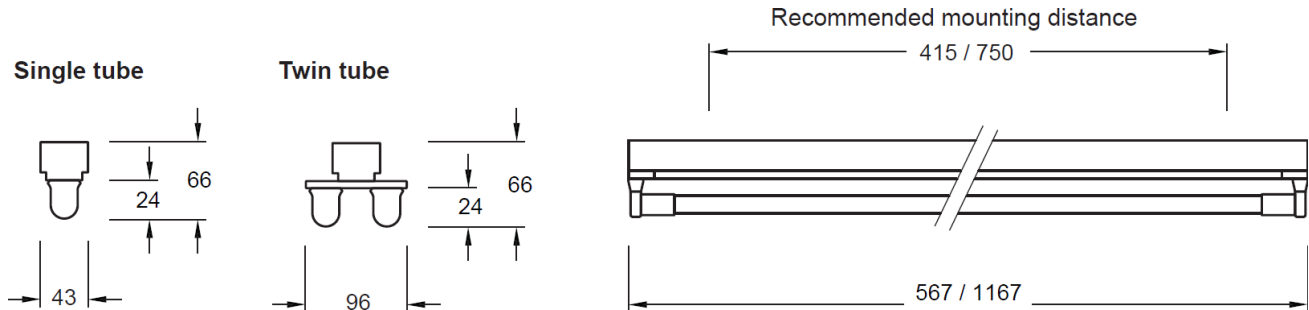

#### Cautions:

- Installation is to be completed by a competent licensed electrician, in accordance with these instructions and relevant local regulations.
- Electronic control equipment must not be subjected to high voltages, DO NOT MEGGER between Live and Neutral.
- All cable/conduit terminations must be installed in accordance with the designated IP rating of this product.
- Suitable installation fastening methods should be employed to ensure the mounting points are not damaged when subjected to vibration and or movement.

#### Installation:

1. Loosen screws at both end of the fitting to remove cover plate.

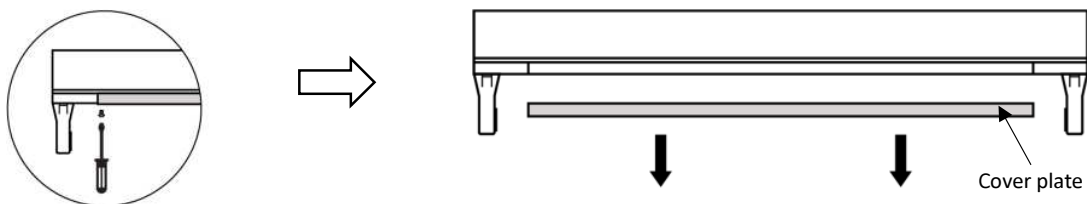

2. Mount the fitting to ceiling with screws.

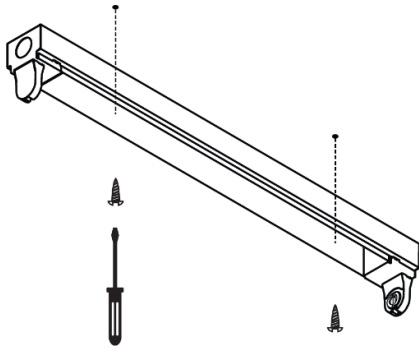

3. Connect incoming supply cables to the terminal block.

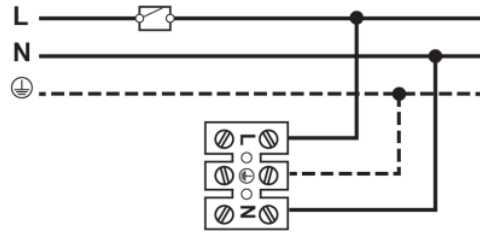

4. Install cover plate to the fitting and tighten with screws properly.

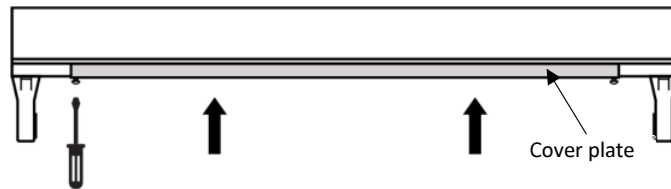

5. Install LED tube to lamp holders and secure by turning it 90°.

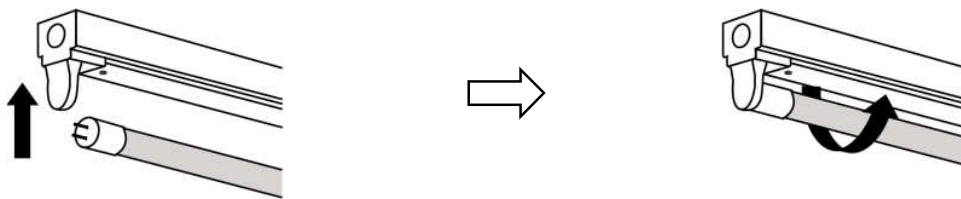

**Wiring Installation for Type B LED Lamp**

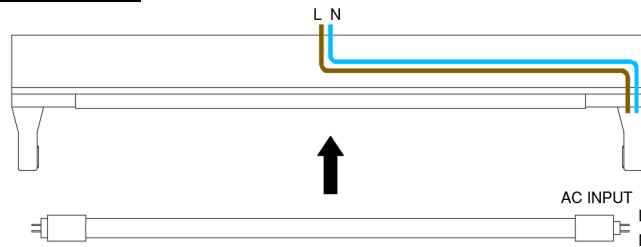

**Type B LED Lamp**

**Maintenance:** The supply must be isolated before opening or accessing the luminaire. Product maintenance is critical to the products designed performance. The product is to be maintained in accordance with the manufacturer’s instructions. For the latest product maintenance guides please go to [www.davislighting.com](http://www.davislighting.com). Davis Lighting is not responsible for any product not maintained in accordance with the recommended procedure or intervals. For recommended LAMP / LED maintenance guides, please refer to the lamp installation guidelines supplied with the lamp product or the nominated lamp manufacturer’s website. Products supplied with visors or covers must not be operate with a damaged visor or cover; it is recommended damaged visors or covers be replaced by a competent person immediately.

